

FEATURES

- UL 60950 recognised for reinforced insulation
- ANSI/AAMI ES60601-1, 1 MOPP/ 2 MOOPs recognised
- 3kVAC isolation test voltage 'Hi Pot Test'
- Continuous short circuit protection
- Output Voltage Trim
- Remote on/off pin
- No electrolytic capacitors
- Operating temperature range -40°C to 100°C
- 2:1 Input Range

PRODUCT OVERVIEW

The MTC1 series of miniature surface mount DC-DC converters offers a single output voltage from input voltage ranges of 9-18V and 18-36V. The MTC1 series regulated output voltage is adjustable by $\pm 10\%$ and a remote on/off pin is also included for application power saving.

The MTC1 ideally suited to applications which include medical, industrial, telecommunications, battery powered systems, and process automation.

SELECTION GUIDE

Order Code ¹	Input Voltage	Output Voltage	Output Current	Rated Input Current	Efficiency		Ripple and Noise		MTTF ²	
	Nom. V	V	mA	mA	Min. %	Typ. %	Typ. mVp/p	Max. mVp/p	MIL kHrs	Telecordia kHrs
MTC1S1203MC	12	3.3	303	110	72	75	25	50	1143	17407
MTC1S1205MC	12	5	200	110	77	78.5	25	50	1129	17407
MTC1S1212MC	12	12	83	100	77	79	20	40	977	17407
MTC1S2403MC	24	3.3	303	55	73	75.5	30	55	1042	17109
MTC1S2405MC	24	5	200	55	74	76.5	25	50	990	17109
MTC1S2412MC	24	12	83	55	75	77	25	50	833	17109

INPUT CHARACTERISTICS

Parameter	Conditions	Min.	Typ.	Max.	Units
Voltage range	12V input types	9	12	18	V
	24V input types	18	24	36	
Input reflected ripple current	All variants		2		mA p-p

OUTPUT CHARACTERISTICS

Parameter	Conditions	Min.	Typ.	Max.	Units
Rated power	All output types			1	W
Minimal load to meet datasheet specification		10			%
Voltage set point accuracy	3V, 5V output types	-2.5		2	%
	12V output types	-3		2	
Line regulation	Low line to high line		± 0.05	± 0.2	%
Load regulation	All output types		± 0.25	± 0.5	%
Transient response	Peak deviation (25-75% & 75-25% swing)	2403 variant		± 4	%V _{out}
		2405 variant		± 3	
		All other variants		± 2	
	Settling time (within 5% V _{out} Nom.)	1203		220	μ s
		1205		260	
	1212, 2403 & 2405		100		
	2412		70		

ISOLATION CHARACTERISTICS

Parameter	Conditions	Min.	Typ.	Max.	Units
Isolation test voltage	Production tested for 1 second	3000			VAC
	Qualification tested for 1 minute	3000			VAC
Isolation capacitance	All variants		7		pF
Resistance	Viso = 1kVDC	1			GΩ



1. Components are supplied in tape and reel packaging, please refer to package specification section. Orderable part numbers are MTC1SXXXXMC-R7 (30 pieces per reel), or MTC1SXXXXMC-R13 (150 pieces per reel)
 2. Calculated using MIL-HDBK-217 FN2 and Telecordia SR-332 calculation model with nominal input voltage at full load.

All specifications typical at T_a=25°C, nominal input voltage and rated output current unless otherwise specified.

GENERAL CHARACTERISTICS¹

Parameter	Conditions	Min.	Typ.	Max.	Units
Switching frequency	1203, 2405, 2403 variants		240		kHz
	1205, 2412 variants		260		
	1212 variant		300		
Remote on/off pin	Module on, pin unconnected or open collector floating				V
	Module off (refer to application notes)		2		
	12V input types		1.5		mW
	24V input types		3.9		

TEMPERATURE CHARACTERISTICS

Parameter	Conditions	Min.	Typ.	Max.	Units
Operation		-40		100	°C
Storage		-50		125	
Case temperature above ambient	100% Load, Nom V _{IN} , Still Air		15		

ABSOLUTE MAXIMUM RATINGS

Short-circuit protection (for SELV input voltages)	Continuous
Remote on/off pin input voltage	6V
Input voltage, MTC1 12V input types	25V
Input voltage, MTC1 24V input types	40V

APPLICATION NOTES

Maximum Output Capacitance

Maximum output capacitance should not exceed:

Output Voltage	Maximum Load Capacitance
V	μF
3.3	470
5	470
12	220

Start-up times

Typical start up times for this series, with a typical input voltage rise time of 2.2μs and output capacitance of 10μF, are shown in the table below. The product series will start into the maximum output capacitance with increased start times.

Part No.	Start-up times
	ms
MTC1S1203MC	5
MTC1S1205MC	14
MTC1S1212MC	25
MTC1S2403MC	9
MTC1S2405MC	14
MTC1S2412MC	25

Typical Wave Form:

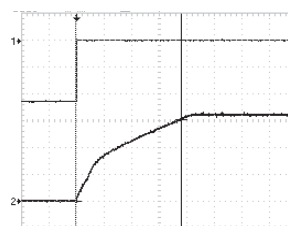

APPLICATION NOTES

Control Pin

The MTC1 converters have a shutdown feature which enables the user to put the converter into a low power state. The control pin connects directly to the base of an internal transistor, and the switch off mechanism for the MTC1 works by forward biasing this NPN transistor. If the pin is left open (high impedance), the converter will be ON (there is no allowed low state for this pin), but once a control voltage is applied with sufficient drive current, the converter will be switched OFF. A suitable application circuit is shown below.

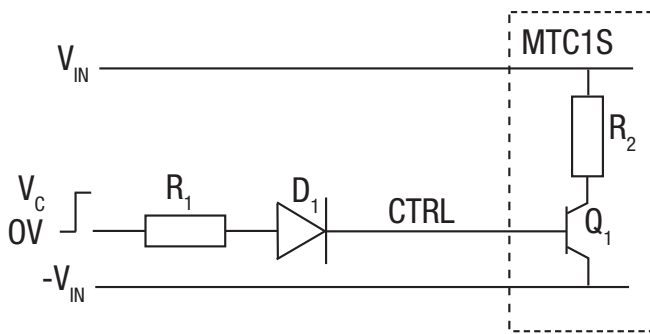

D₁ (e.g. 1N4001) is required to provide high impedance when the signal is low. From the MTC1 specification, the drive current to operate this function is recommended to be 3mA to 8mA, and hence the value of R₁ can be derived as follows:

$$R_1 = \frac{V_C - V_D - 0.6}{I_B}$$

Assuming V_C=5V, V_D=0.7V:

$$R_1 = \frac{5 - 0.7 - 0.6}{5 \times 10^{-3}} = 732\Omega \text{ (E96, 1\% resistor)}$$

For 5V TTL signal:
Set R1 to be 82Ω or less

Output Voltage Adjustment

The MTC1S series has a trim capability which is located at pin 3, this allows the user to independently adjust the output voltages by ±10%. Adjustments to the output voltages can be accomplished via a single fixed resistor as shown in Figures 1 and 2. A single fixed resistor can increase or decrease the output voltage depending on its connection. Fixed resistors should have low temperature coefficient to minimize sensitivity to changes in temperature.

A single resistor connected from the TRIM pin (pin 3) to the +V_{out} (pin 4), will decrease the output voltage which is shown in figure 1.

A single resistor connected from the TRIM pin (pin 3) to the -V_{out} (pin 2) will increase the output voltage which is shown in figure 2.

TRIM DOWN

Figure 1. Trim connections to decrease the output voltage

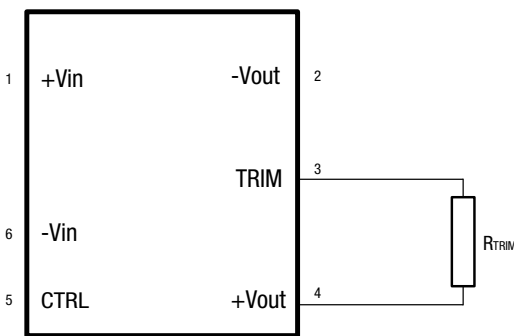

$$3.3V_{out} R_{TRIM} = \frac{18.64k \times V_{out} - 52.3k}{3.32 - V_{out}}$$

$$5V_{out} R_{TRIM} = \frac{33.2k \times V_{out} - 141k}{5 - V_{out}}$$

$$12V_{out} R_{TRIM} = \frac{21.5k \times V_{out} - 171.29k}{11.979 - V_{out}}$$

TRIM UP

Figure 2. Trim connections to increase the output voltage

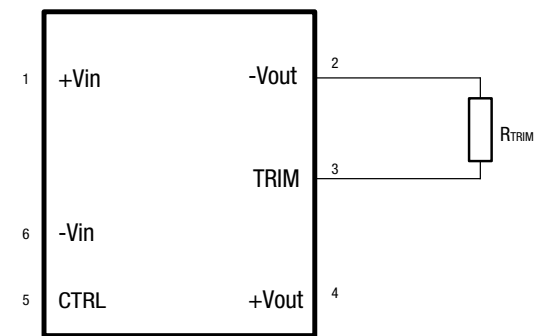

$$3.3V_{out} R_{TRIM} = \frac{14k \times V_{out} - 52.3k}{3.32 - V_{out}}$$

$$5V_{out} R_{TRIM} = \frac{23.2k \times V_{out} - 141k}{5 - V_{out}}$$

$$12V_{out} R_{TRIM} = \frac{12.4k \times V_{out} - 171.29k}{11.979 - V_{out}}$$

Accuracy of adjustment is subject to tolerances of resistors and factory adjusted output accuracy. V_{out} is equal to the desired output voltage.

TECHNICAL NOTES

ISOLATION VOLTAGE

‘Hi Pot Test’, ‘Flash Tested’, ‘Withstand Voltage’, ‘Proof Voltage’, ‘Dielectric Withstand Voltage’ & ‘Isolation Test Voltage’ are all terms that relate to the same thing, a test voltage, applied for a specified time, across a component designed to provide electrical isolation, to verify the integrity of that isolation.

Murata Power Solutions MTC1 series of DC-DC converters are all 100% production tested at 3kVAC for 1 second and have been qualification tested at 3kVAC for 1 minute. A question commonly asked is, “What is the continuous voltage that can be applied across the part in normal operation?”

The MTC1 series has been recognized by Underwriters Laboratory to 250 Vrms Reinforced Insulation, please see safety approval section below.

REPEATED HIGH-VOLTAGE ISOLATION TESTING

It is well known that repeated high-voltage isolation testing of a barrier component can actually degrade isolation capability, to a lesser or greater degree depending on materials, construction and environment. We therefore strongly advise against repeated high voltage isolation testing, but if it is absolutely required, that the voltage be reduced by 20% from specified test voltage.

SAFETY APPROVAL

ANSI/AAMI ES60601-1

The MTC1 series has been recognised by Underwriters Laboratory (UL) to ANSI/AAMI ES60601-1 and provides 1 MOPP (Means Of Patient Protection) and 2 MOOP (Means Of Operator Protection) based upon a working voltage of 250 Vrms max., between Primary and Secondary. File number E202895 applies.

UL 60950

The MTC1 series has been recognised by Underwriters Laboratory (UL) to UL 60950 for reinforced insulation to a working voltage of 250 Vrms. File number E151252 applies.

FUSING

The MTC1 Series of converters are not internally fused so to meet the requirements of UL an anti-surge input line fuse should always be used with ratings as defined below.

Input Voltage, 12V: 0.5A

Input Voltage, 24V: 0.25A

All fuses should be UL recognized and rated to 125V.

RoHS COMPLIANCE INFORMATION, MSL



This series is compatible with RoHS soldering systems with a peak reflow solder temperature of 245°C as per J-STD-020D.1. The pin termination finish on this product series is Gold with Nickel Pre-plate. The series is backward compatible with Sn/Pb soldering systems. The series has a Moisture Sensitivity Level (MSL) 1.

CHARACTERISATION TEST METHODS

Ripple & Noise Characterisation Method

Ripple and noise measurements are performed with the following test configuration.

C1	1µF X7R multilayer ceramic capacitor, voltage rating to be a minimum of 3 times the output voltage of the DC-DC converter
C2	10µF tantalum capacitor, voltage rating to be a minimum of 1.5 times the output voltage of the DC-DC converter with an ESR of less than 100mΩ at 100 kHz
C3	100nF multilayer ceramic capacitor, general purpose
R1	450Ω resistor, carbon film, ±1% tolerance
R2	50Ω BNC termination
T1	3T of the coax cable through a ferrite toroid
RLOAD	Resistive load to the maximum power rating of the DC-DC converter. Connections should be made via twisted wires

Measured values are multiplied by 10 to obtain the specified values.

Differential Mode Noise Test Schematic

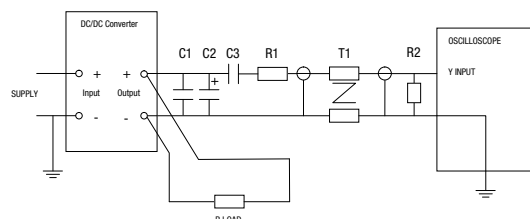

EFFICIENCY VS LOAD

MTC1S1203MC

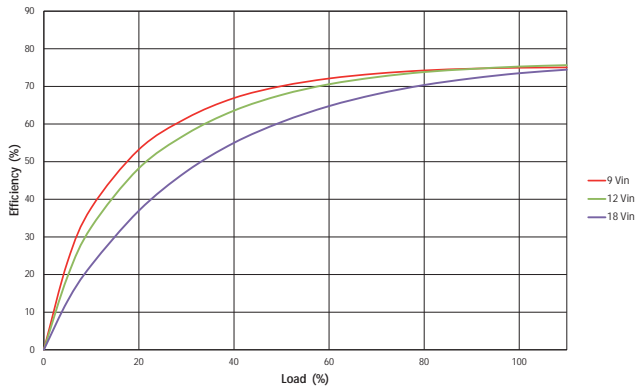

MTC1S1205MC

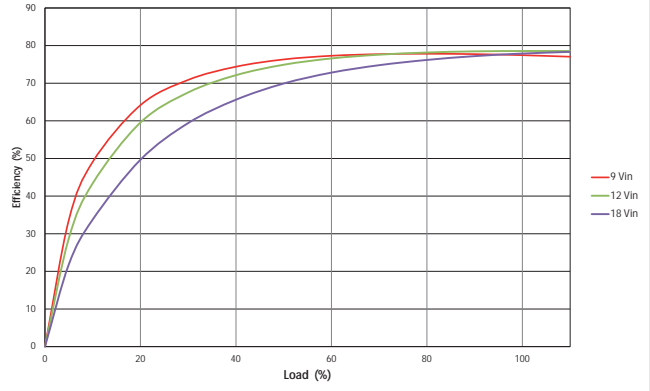

MTC1S1212MC

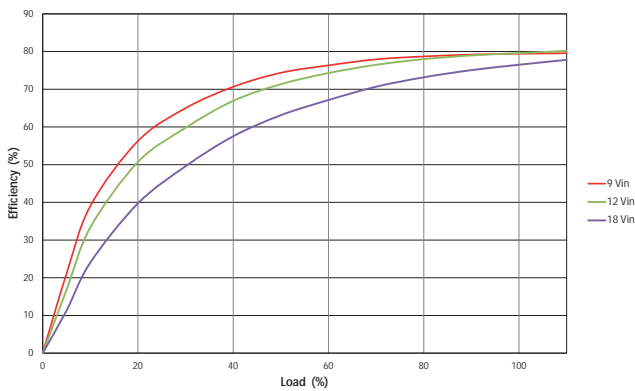

MTC1S2403MC

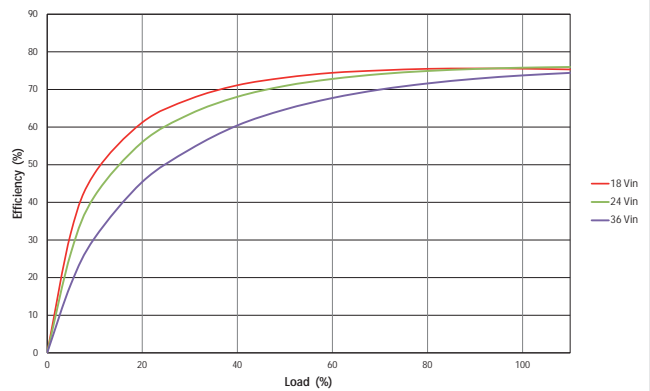

MTC1S2405MC

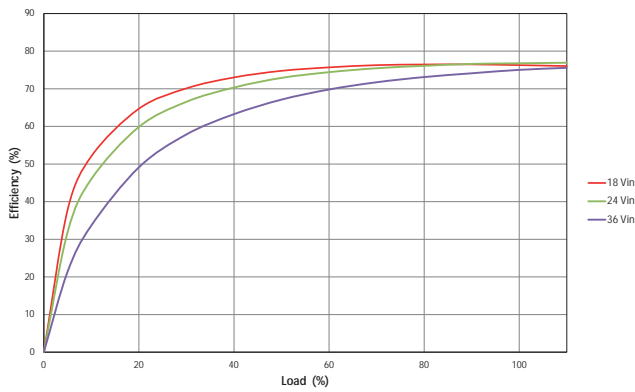

MTC1S2412MC

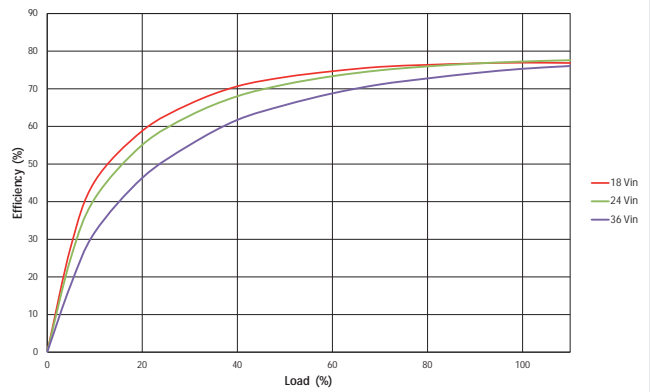

DERATING GRAPHS

MTC1S1203MC - 12Vin

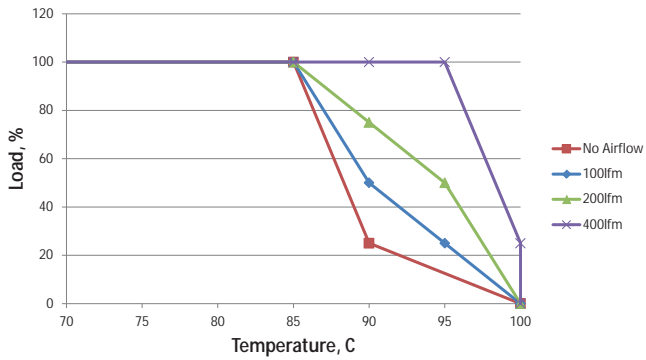

MTC1S1205MC - 12Vin

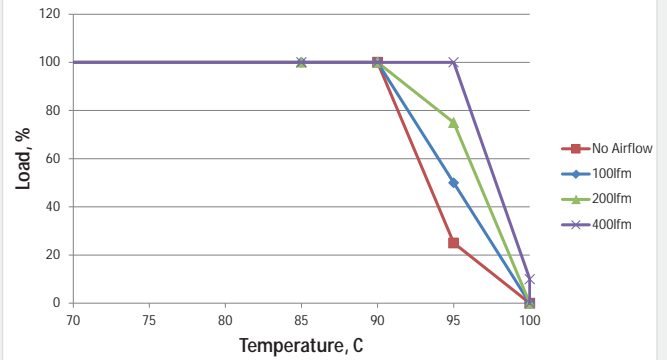

MTC1S1212MC - 12Vin

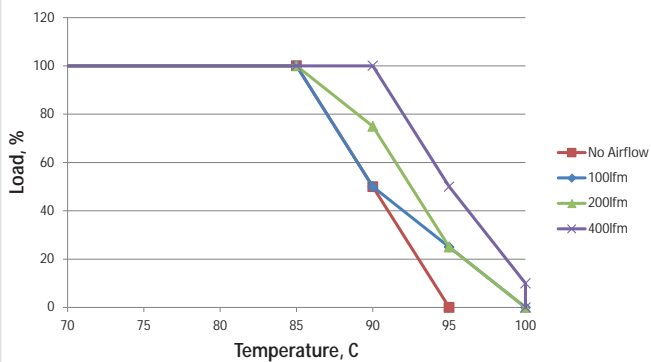

MTC1S2403MC - 24Vin

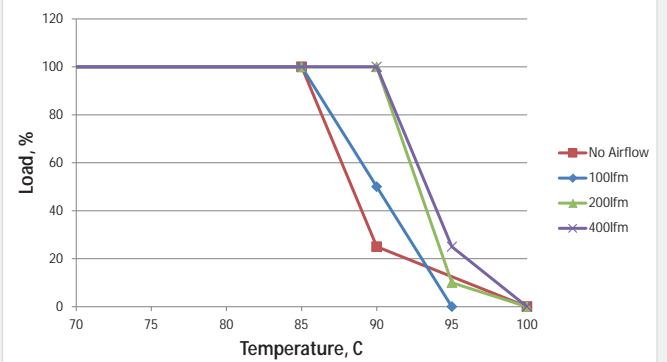

MTC1S2405MC - 24Vin

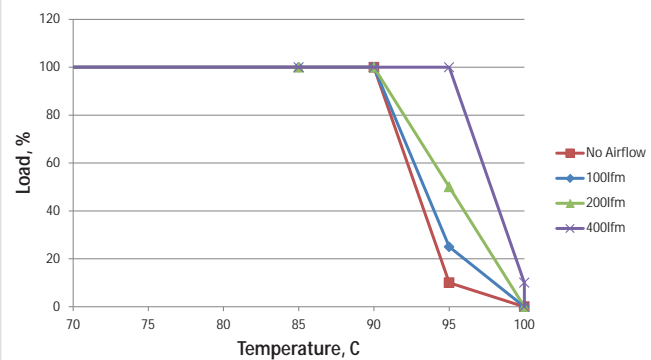

MTC1S2412MC - 24Vin

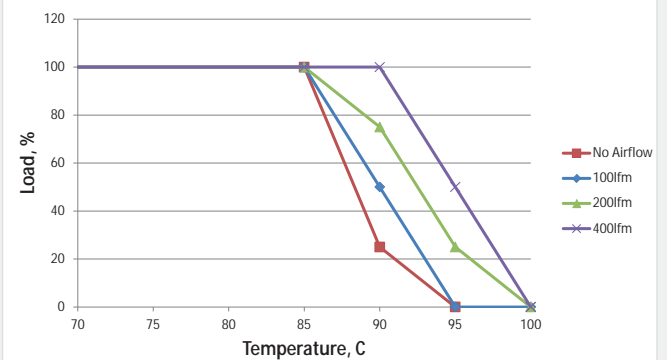

DERATING GRAPHS

MTC1S1203MC - 9Vin

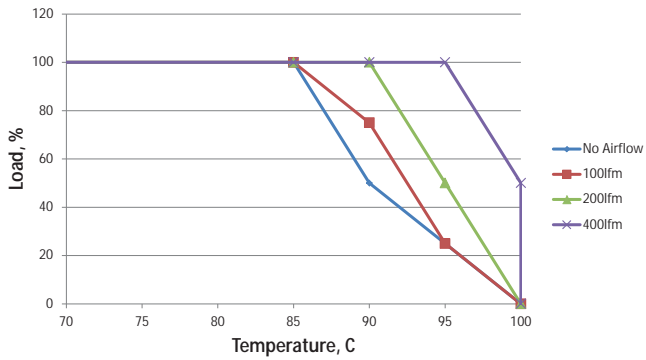

MTC1S1205MC - 9Vin

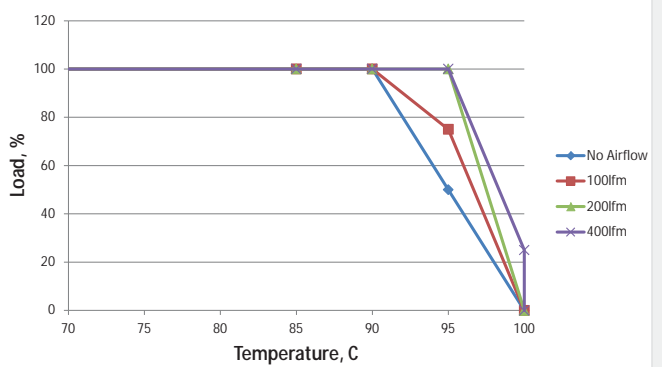

MTC1S1212MC - 9Vin

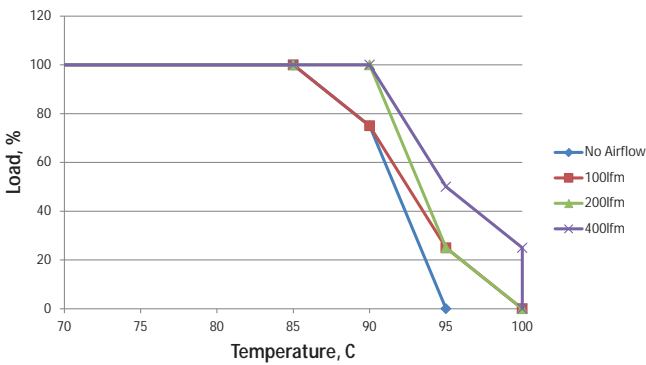

MTC1S2403MC - 18Vin

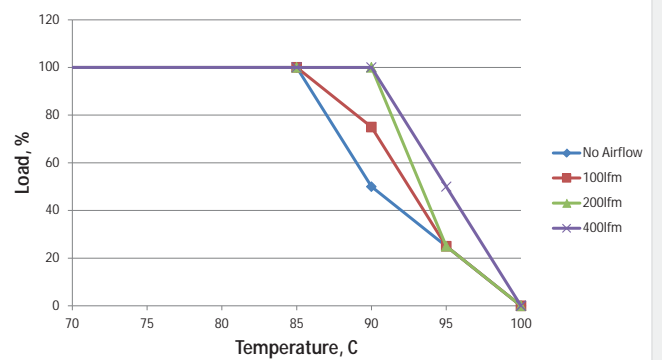

MTC1S2405MC - 18Vin

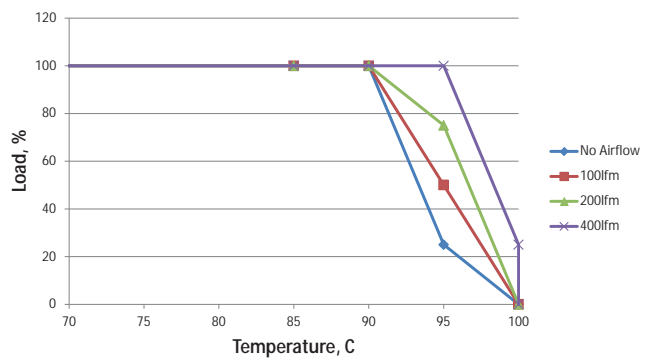

MTC1S2412MC - 18Vin

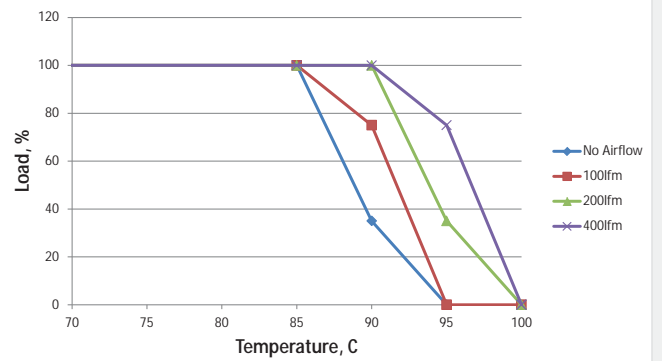

DERATING GRAPHS

MTC1S1203MC - 18Vin

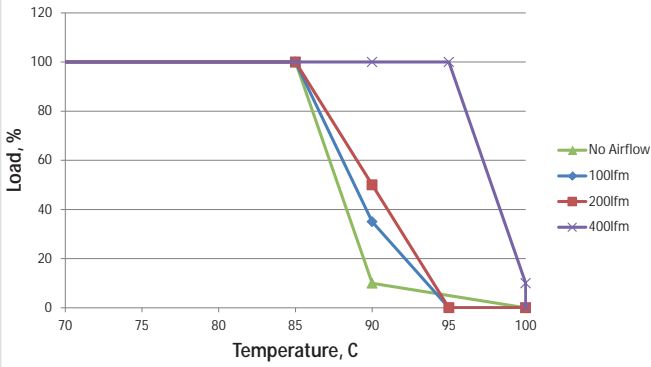

MTC1S1205MC - 18Vin

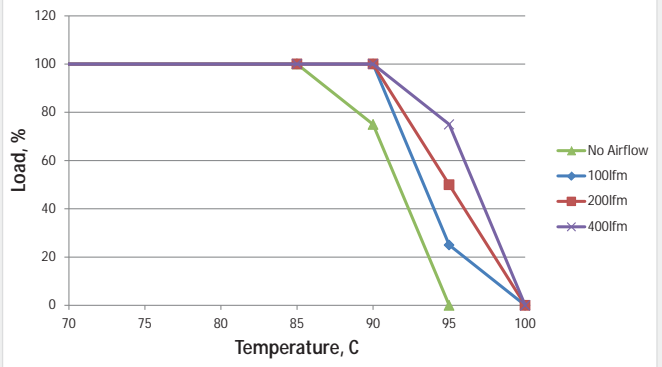

MTC1S1212MC - 18Vin

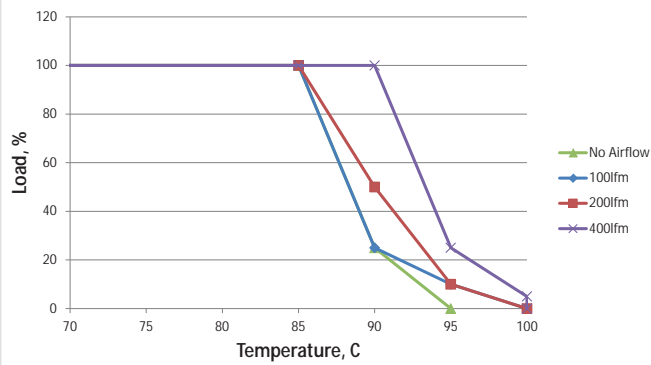

MTC1S2403MC - 36Vin

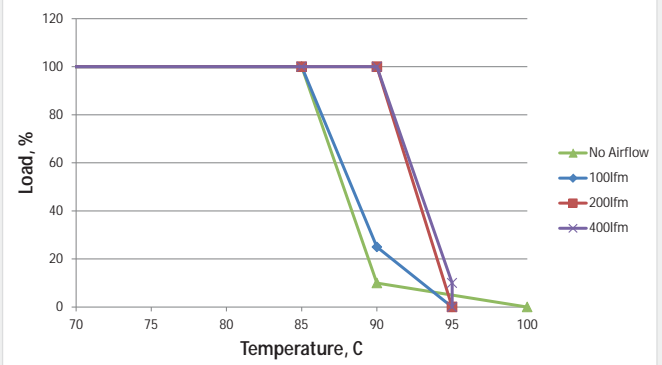

MTC1S2405MC - 36Vin

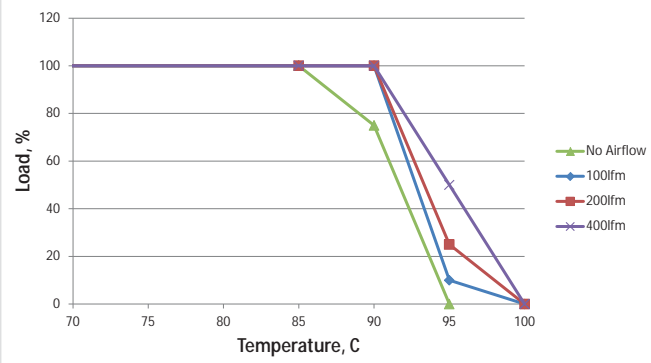

MTC1S2412MC - 36Vin

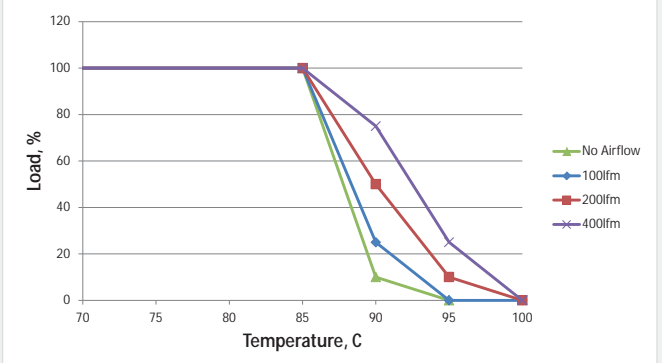

EMC FILTERING AND SPECTRA

FILTERING

The module includes a basic level of filtering. With the addition of an input capacitor of 680nF and input inductor 10μH that are typically required to meet EN 55022 Curve A Quasi-Peak EMC limit, as shown in the following plots.

MTC1S1203MC

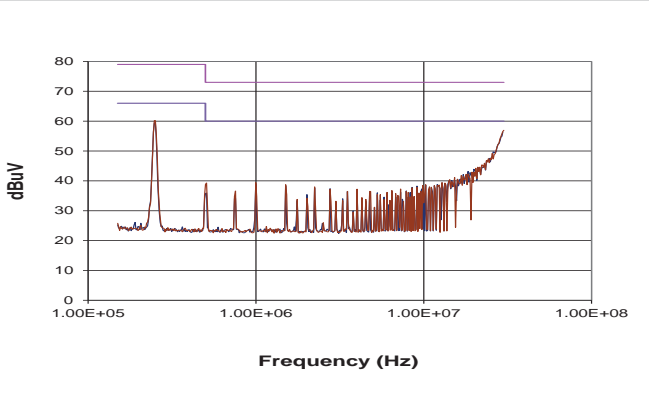

MTC1S1205MC

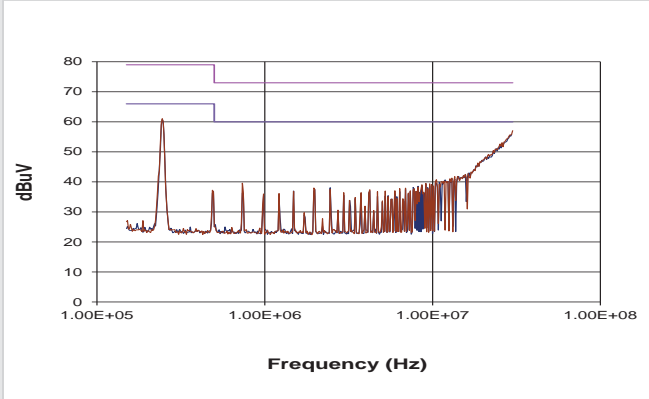

MTC1S1212MC

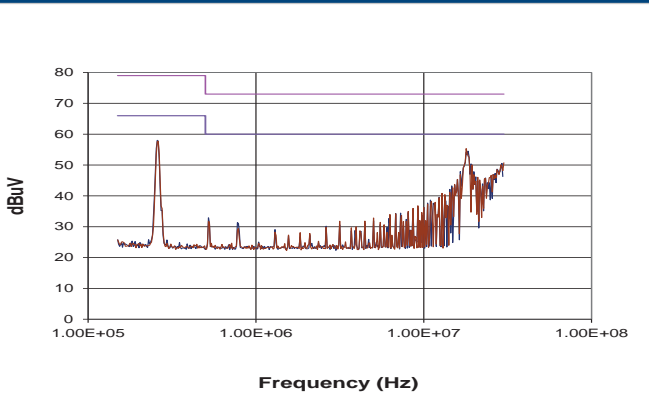

MTC1S2403MC

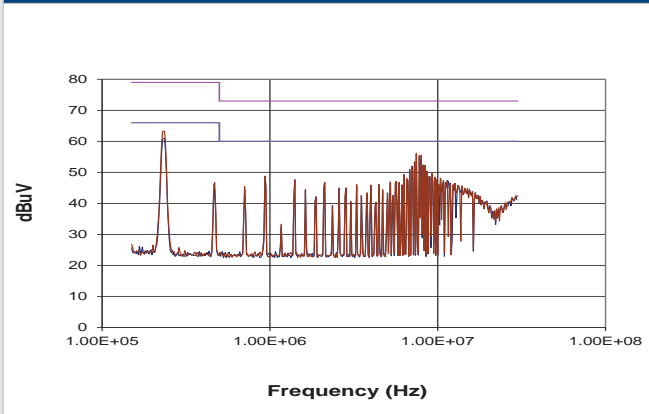

MTC1S2405MC

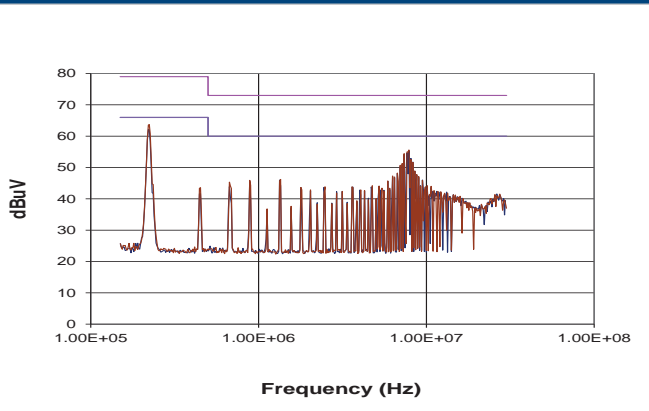

MTC1S2412MC

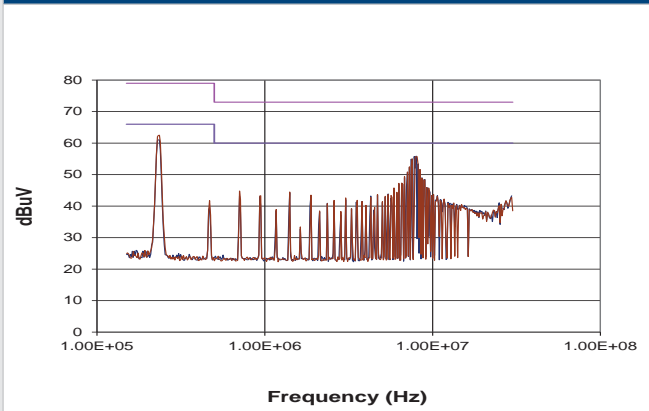

PACKAGE SPECIFICATIONS

Mechanical Dimensions

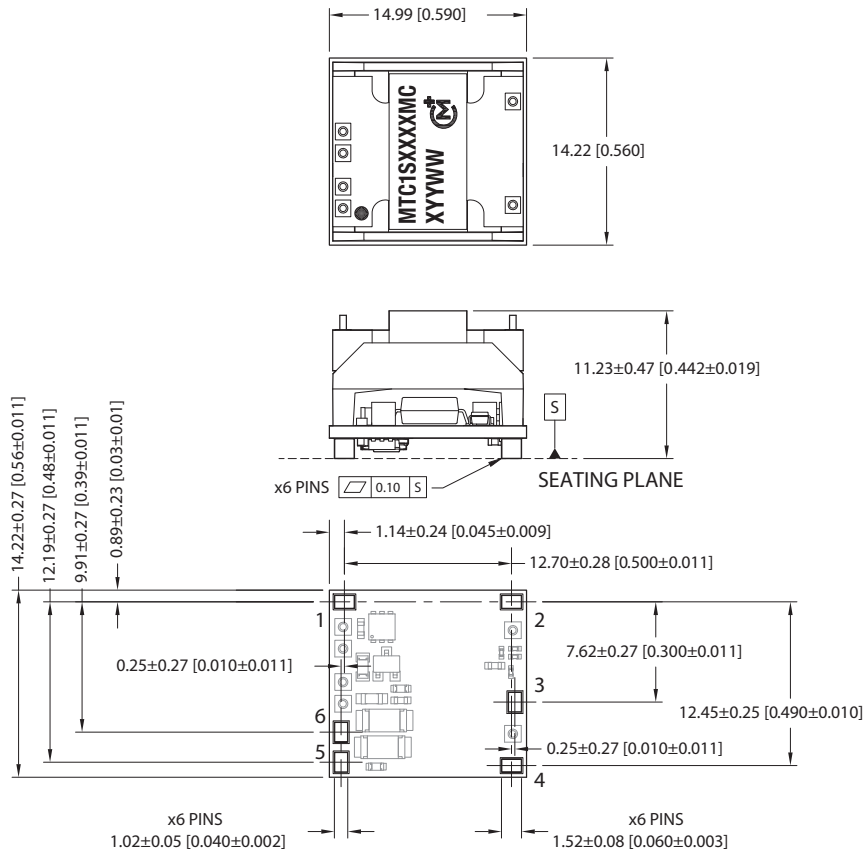

Pin Connections

Pin	Function
1	+Vin
2	-Vout
3	Trim
4	+Vout
5	Ctrl
6	-Vin

All dimensions in mm(inches), Controlling dimension is mm. Tolerances (unless otherwise stated) ±0.10(0.004).
Components shown for reference only

Weight: 3.4g

Recommended Footprint Details

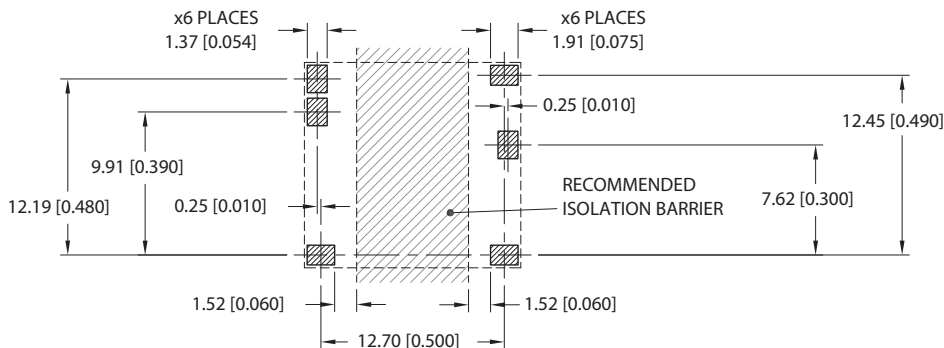

TAPE & REEL SPECIFICATIONS

REEL OUTLINE DIMENSIONS

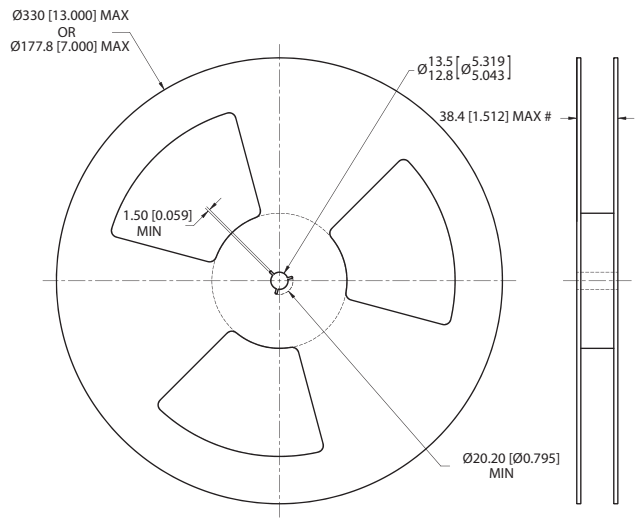

Tape & Reel specifications shall conform with current EIA-481 standard
 Unless otherwise stated all dimensions in mm(inches)
 Controlling dimension is mm
 # Measured at hub

REEL PACKAGING DETAILS

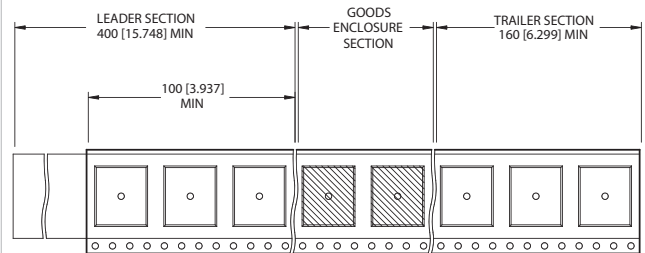

Carrier tape pockets shown are illustrative only - Refer to carrier tape diagram for actual pocket details.

Reel Quantity: 7" - 30 or 13" - 150

TAPE OUTLINE DIMENSIONS

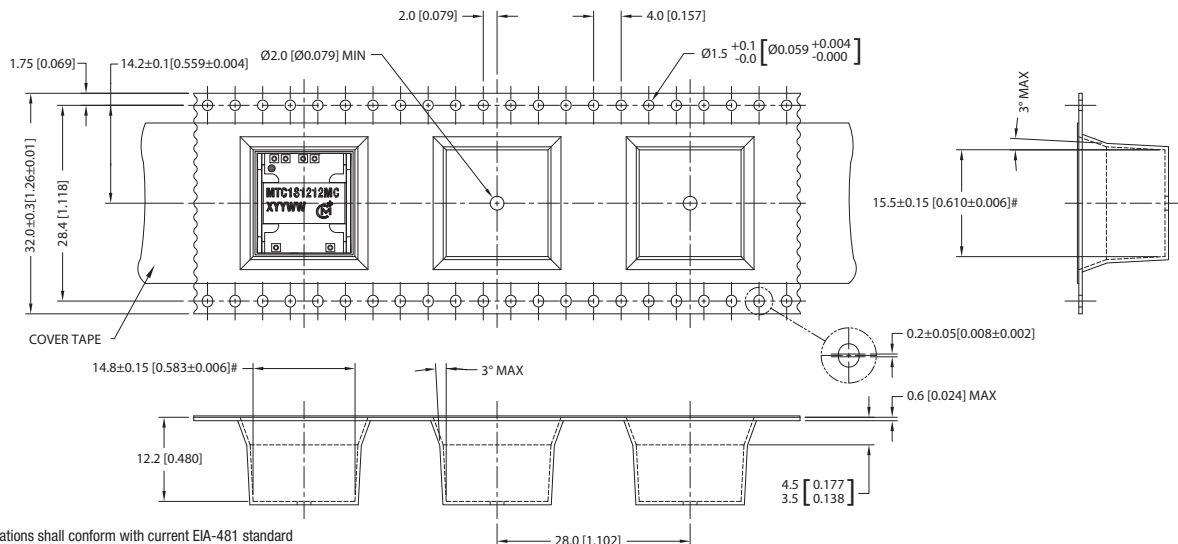

Tape & Reel specifications shall conform with current EIA-481 standard
 Unless otherwise stated all dimensions in mm(inches) ±0.1mm (±0.004 inches)
 Controlling dimension is mm
 Components shall be orientated within the carrier tape as indicated
 # Measured on a plane 0.3mm above the bottom pocket



This product is subject to the following **operating requirements** and the **Life and Safety Critical Application Sales Policy**:
 Refer to: <http://www.murata-ps.com/requirements/>

Murata Power Solutions, Inc. makes no representation that the use of its products in the circuits described herein, or the use of other technical information contained herein, will not infringe upon existing or future patent rights. The descriptions contained herein do not imply the granting of licenses to make, use, or sell equipment constructed in accordance therewith. Specifications are subject to change without notice.
 © 2017 Murata Power Solutions, Inc.